

General
information

Getting
Started

Operation

Starting to
Print Cards

Cleaning

Trouble
Shooting

Technical
Specifications

User's manual

J A V E L I N™ J330

www.engenyus.com



J A V E L I N

© engenyus - August 2002

General
information

Getting
Started

Operation

Starting to
Print Cards

Cleaning

Trouble
Shooting

Technical
Specifications

FOREWORD

This manual provides installation and operation information for the engenyus JAVELIN J330 card printers.

TECHNICAL SUPPORT

If for any reason you require product technical support, please contact the distributor where you purchased your equipment. If they cannot help you, or at their direction, engenyus can be reached at :

engenyus limited
7 Byfleet Technical Centre
Canada Road
West Byfleet
Surrey

United Kingdom KT14 7NB

Tel : +44 1932 351531

Fax : +44 1932 351382

Email : technical.support@engenyus.co.uk

HOW TO RETURN YOUR PRINTER

If you have purchased your printer from an NBS distributor, please first contact them on their returns procedures.

Alternatively, if you have been advised to return your printer to engenyus, please follow these procedures:

- 1) Before calling or returning any goods, ensure that you are able to provide the following information:
 - the product serial number
 - a brief description of the reason for return
 - if applicable, your technical support call reference number.
- 2) Contact engenyus customer services department on +44 (0) 1932 351531.
- 3) You will be given a Returns Materials Advice (RMA) number.
- 4) Pack the goods in their original packaging along with any sample cards, if appropriate, and mark the RMA number clearly on the outside of the package.
- 5) Return the printer to engenyus at the address as shown above.

Note: It is advisable to send the package via registered mail or a recognised courier service to ensure confirmation of delivery.

Continued on next page

General
information

Getting
Started

Operation

Starting to
Print Cards

Cleaning

Trouble
Shooting

Technical
Specifications



Only complete goods in their original packaging with a valid **Returned Materials Advice (RMA)** number clearly marked on the outside can be accepted for return to engenyus.

COPYRIGHT NOTICE

This document contains information proprietary to engenyus. This document and the information contained within is copyrighted by engenyus and may not be duplicated in full or in part by any person without written approval from engenyus. While every effort has been made to keep the information contained within current and accurate as of the date of publication, no guarantee is given or implied that the document is error-free or that it is accurate with regard to any specification. engenyus reserves the right to make changes, for the purpose of product improvement, at any time.

General
information

Getting
Started

Operation

Starting to
Print Cards

Cleaning

Trouble
Shooting

Technical
Specifications

TRADEMARKS

JAVELIN is a trademark of engenyus limited. Windows and MS-DOS are registered trademarks of Microsoft Corp. All other marks are trademarks or registered trademarks of their respective holders.

WARRANTY INFORMATION

PRINTERS

All NBS JAVELIN™ printers are warranted against defects in material or workmanship for twelve (12) months from the date of purchase by the end user. Proof of purchase or shipment date is required to validate the warranty period. The warranty becomes void if the equipment is modified, improperly installed or used, damaged by accident or neglect, or if any parts are improperly installed or replaced by the user.

SUPPLIES

These are warranted to be free from defect in material and workmanship for a period of six (6) months for media and twelve (12) months for ribbon from the date of shipment provided the user has complied with storage guidelines, handling and usage of the supplies within engenyus Javelin printers.

PRINTHEADS

Since print head wear is part of normal operation, the original print head is covered by a twelve (12) month warranty. Warranty period begins on purchase date. To qualify for this warranty, the print head must be returned to engenyus or to an authorised dealer. Customers are not required to purchase engenyus supplies (media and/or ribbons) for warranty qualification. However, if it is determined that the use of other manufacturers' supplies has caused any defect in the print head for which a warranty claim is made, the user is responsible for all charges required to repair the defect. The warranty becomes void if the print head is physically worn or damaged; also if it is determined that failure to follow the preventive maintenance schedule listed in the User's Manual has caused defects in the thermal print head for which a warranty claim is made.



General
information

Getting
Started

Operation

Starting to
Print Cards

Cleaning

Trouble
Shooting

Technical
Specifications

SPARE PARTS

All parts, maintenance kits, options kits, and accessories are warranted to be free of defects in material and workmanship for 90 days from date of purchase (except where otherwise noted). This warranty become void if the item is modified, improperly installed or used, or damaged by accident or neglect.

Failure to exercise caution to protect the equipment from electrostatic discharge damage, adverse temperature and humidity conditions or physical abuse, including, but not limited to, improper packaging, shipping, service or repairs performed by personnel not authorized by engenyus may void the warranty. Failure to use only engenyus approved media may void the warranty. engenyus will, at its option, repair or replace the equipment or any parts which are determined to be defective within this warranty period, and which are returned to engenyus F.O.B. factory of origin.

The warranty set forth above is exclusive and no other warranty, whether written or oral, is expressed or implied. Engenyus specifically disclaims the implied warranties of merchantability and fitness for a particular purpose.

General
information

Getting
Started

Operation

Starting to
Print Cards

Cleaning

Trouble
Shooting

Technical
Specifications

DECLARATIONS OF CONFORMITY



European Council Directive		Compliance to Standards	
89/336/EEC modified by 92/31/EEC and 93/68/EEC	EMC Directive	EN 55022-B	RF Emissions control
	EMC Directive	EN 500082-1, 1992	Immunity to Electromagnetic Disturbances
73/23/EEC modified by 93/68/EEC	Low voltage Directive	EN 60950	Product Safety



Model: J330 conforms to the following specification:
FCC Part 15, Subpart A, Section 15.107(a) and Section 15.109(a) Class A digital device

Supplemental Information:

This device complies with Part 15 of the FCC rules. Operation is subject to the following two conditions: (1) This device may not cause harmful interference, and (2) this device must accept any interference received, including interference that may cause undesired operation.

Note:

This equipment has been tested and found to comply with the limits for a class A digital device, pursuant to Part 15 of the FCC Rules. These limits are designed to provide reasonable protection against harmful interference when the equipment is operated in a commercial environment. This equipment generates, uses, and can radiate radio frequency energy and, if not installed and used in accordance with the instruction manual, may cause harmful interference to radio communications. Operation of this equipment in a residential area is likely to cause harmful interference in which case the user will be required to correct the interference at his own expense.

INDUSTRY CANADA NOTICE

This device complies with Industry Canada ICS-003 class A requirements.



General information



Getting Started



Operation



Starting to Print Cards



Cleaning



Trouble Shooting



Technical Specifications

INTRODUCTION

Thank you for choosing the Javelin J330 plastic card printer.

These printers produce cards ideal for personalised identification, access control, visitor, membership, promotion and luggage card, badges and tags.

This manual guides you to an efficient start up and operation of your new card printer.

J330 PRINTER MODELS

Here is a quick review of the Javelin card printer series numbering and lettering system to help you.

The Javelin J330 plastic card printer employs dye sublimation and resin thermal transfer technologies. Model numbers include identifiers that specify options are shown using the following lettering conventions:

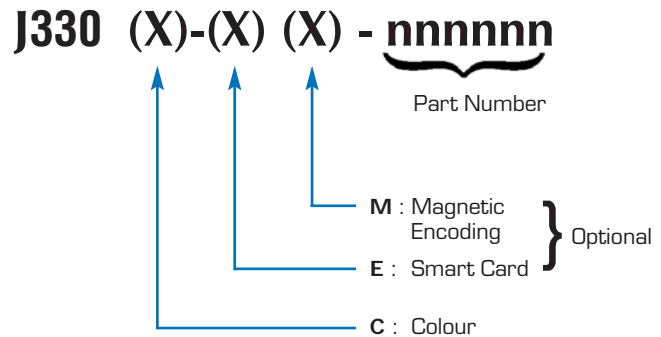

This information can be found on the printer serial number panel and is also shown on the test card.

General information

Getting Started

Operation

Starting to Print Cards

Cleaning

Trouble Shooting

Technical Specifications

ICONS

Throughout this manual, different icons highlight important information, as follows:



Important general information



Mechanical hazard, such as one associated with moving parts, capable of resulting in equipment damage or personal injury.



Electrical hazard, such as an exposed voltage point, capable of causing electrical shock and personal injury.



An area where electrostatic discharge (ESD) can cause component damage. Use a grounding wrist band.



Elevated temperature hazard, capable of producing a burn.



Keep card printer clean by minimizing cover open time.

TABLE OF CONTENTS

1	GETTING STARTED	1
1.1	Unpacking your card printer	1
1.2	Indicators and controls	3
1.3	Printer installation	4
2	OPERATION	5
2.1	Printer features	5
2.2	Loading ribbons	6
2.3	Loading cards	8
	A- Card cartridge	8
	B- Card cleaning cartridge	10
	C- Card thickness control lever	11
	D- Card output hopper	11
2.4	Feeding one card at a time	12
2.5	Printing a test card	13
2.6	Printer menu information	14
3	STARTING TO PRINT CARDS	16
	A- Install driver on Windows 95/98	17
	B- Install driver on Windows NT4.0	18
	C- Set printer driver options. Windows NT	18
	D- Set printer driver options. Windows 95/98	19
	E- Set printer driver options and printing a test card	19
4	CLEANING	20
4.1	Cleaning system	21
4.2	Cleaning the print head	22
4.3	Card cleaning cartridge	23
5	TROUBLESHOOTING	25
5.1	Interpreting LCD display messages	25
5.2	Print quality issues	29
6	TECHNICAL SPECIFICATIONS	32

General information

Getting Started

Operation

Starting to Print Cards

Cleaning

Trouble Shooting

Technical Specifications



General information



Getting Started



Operation



Starting to Print Cards



Cleaning



Trouble Shooting



Technical Specifications

APPENDIX A - MAGNETIC CARD STRIPE ENCODER	36
Introduction	36
A- Media loading orientation	37
B- Magnetic encoder cleaning	38
APPENDIX B - SMART CARD CONTACT STATION	39
Introduction	39
A- Media loading orientation	40
B- Smart card contact station interface	40
APPENDIX C - ACCESSORIES & SUPPLIES	41
Ribbons	41
Cards	42
Accessories	43



1 Getting started

1.1 Unpacking your card printer

Your J330 printer ships in a carton and protective anti-static bag. Keep all packing material in case you need to move or re-ship the printer.

While unpacking, inspect the carton to ensure that no damage occurred during shipping.

Please ensure that you have a clean and nearly dust free environment for proper operation and storage of the printer.

General information

Getting Started

Operation

Starting to Print Cards

Cleaning

Trouble Shooting

Technical Specifications

General information

Getting Started

Operation

Starting to Print Cards

Cleaning

Trouble Shooting

Technical Specifications

In addition to user documentation, make sure the following items are included with your J330 printer:

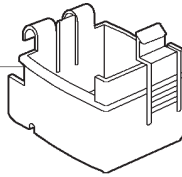

CARD CARTRIDGE

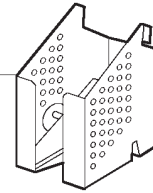

CARD OUTPUT HOPPER

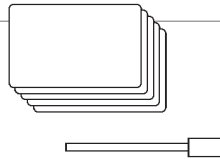

CLEANING KIT

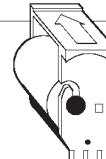

CLEANING CARTRIDGE

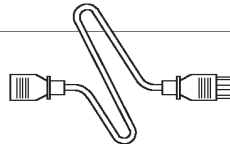

POWER CABLE

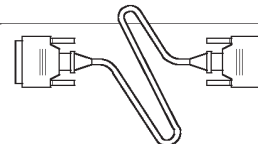

INTERFACE CABLE

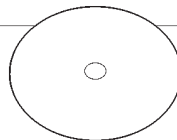

USER MANUAL &
PRINTER DRIVER CD

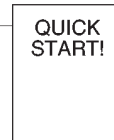

QUICK START GUIDE

If any items are missing, please contact your dealer.

To reorder, please refer to Appendix C of this manual.

General information

Getting Started

Operation

Starting to Print Cards

Cleaning

Trouble Shooting

Technical Specifications

1.2 Indicators and Controls

Your J330 printer has an LCD Display, two LEDs and two Panel Buttons.

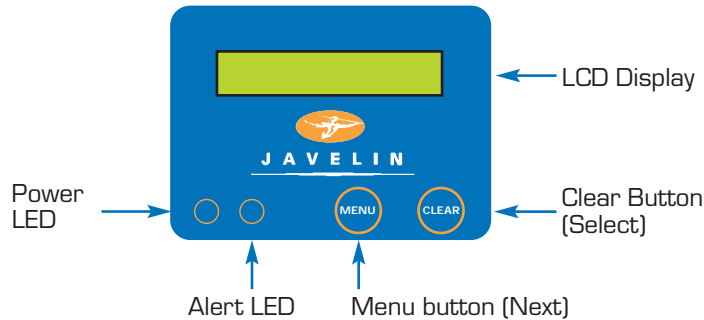

LCD DISPLAY :

The 16 character LCD Display is used for :

- Showing the printer's current status
- Providing operator and service messages (Chapter 5)

LEDS :

The two LEDs are used for :

- Green: Power LED
- Amber: Alert LED (with beeper)

This alert LED is on when an error condition exists.

The beeper will sound three alert "beeps" and the LCD display will show the associated error message.

PANEL BUTTONS:

The menu button (left) is a push button used for:

- Bringing printer into menu mode when pressed with the printer showing READY on the LCD Display.
- Using in menu mode to scroll through menu options.

The Clear Button (right) is a push button used for:

- Clearing an error status (when LCD display shows an error report and alert LED is on).
- Invoking automatic retry of the operation which gave the error.
- Selecting a menu option when in menu mode.

NOTE: the buttons "beep" when pressed



General information



Getting Started



Operation



Starting to Print Cards



Cleaning



Trouble Shooting



Technical Specifications

1.3 Printer Installation

The following will guide you through the installation of your J330 printer.



CAUTION : Limit AC power supplied to the J330 Printer to 110 - 230 V AC, 60 - 50 Hz for an associated 680 mA - 310 mA. Limit excess current draw to 16 amps or less, using an associated circuit breaker or other such device. Never operate the printer in a location where operator, computer, or printer can get wet. Personal injury could result. The printer must be connected to an earthed electrical power supply and properly protected against electrical surges and grounding faults.

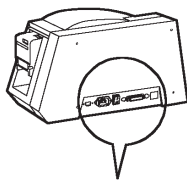

1. Place the printer in a location that allows easy access to all sides. The printer should never be operated while resting on its side or upside down.

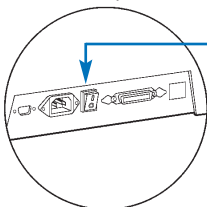

2. Place the printer's power switch in the OFF (O) position.

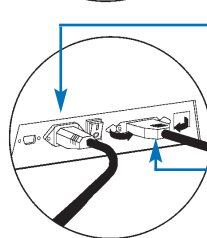

3. Insert the power cable to the printer power socket and attach to grounded electrical socket of the proper voltage and type.

4. Attach interface cable to printer and computer and then secure.

5. Switch power on.



CAUTION: Intermittent or unpredictable operation may occur from unsecured connectors. If damaged, the power cable must be replaced by an exact equivalent.

Use only parallel cable under 3 metres in length.

2 Operation

2.1 Printer Features

The following shows the features found on your J330 printer:

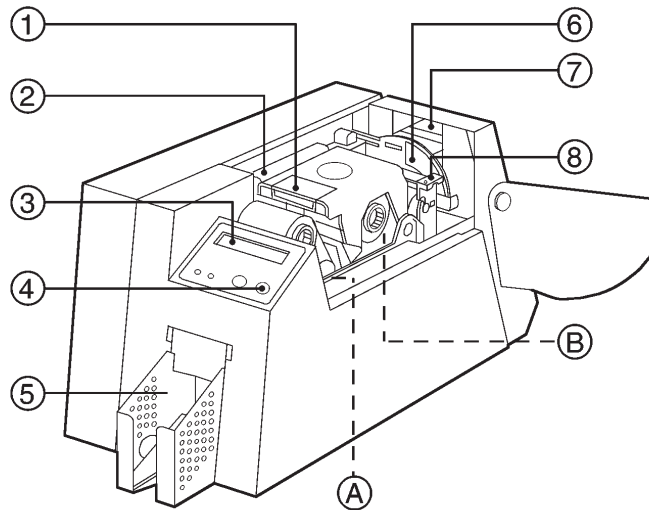

STANDARD FEATURES

1. Print Head
2. Print Head Unlock lever
3. LCD Display
4. 2 Panel Buttons
5. Card Output Hopper
6. Card Thickness Control
7. Card Cartridge
8. Card Cleaning Cartridge

OPTIONAL FEATURES

- A. Magnetic Encoder Station
- B. Smart Card Contact Station

PLEASE NOTE : Any blue items inside the printer can be operated by the user.

General information

Getting Started

Operation

Starting to Print Cards

Cleaning

Trouble Shooting

Technical Specifications

General information

Getting Started

Operation

Starting to Print Cards

Cleaning

Trouble Shooting

Technical Specifications

2.2 Loading Ribbons

The J330 printer requires approved ribbons (See Appendix C).

The resin thermal transfer and dye sublimation ribbons are specifically designed for your J330 printer. For optimum performance and printer life (print head), always use approved ribbons.



DO NOT TOUCH the print head or the electronic components on the print headcarriage. Discharges of electrostatic charge from the human body or other surfaces can damage the print head or other electronic components used in this device.

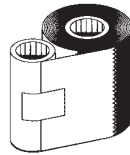

1. Remove ribbon from packaging.

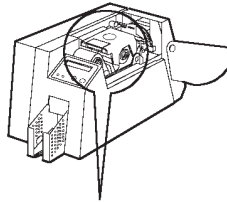

2. With printer power ON and READY status, open cover and press down on the print head unlock lever to open the print head carriage. The print head carriage will pop open.

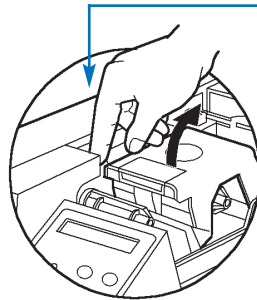

Continued on next page

General information

Getting Started

Operation

Starting to Print Cards

Cleaning

Trouble Shooting

Technical Specifications

SUPPLY SPINDLE

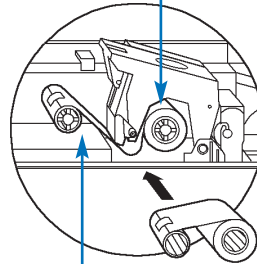

TAKE UP SPINDLE

3. Load ribbon onto the supply spindle (under print head carriage) and empty core (with tape attached) onto the take-up spindle. Make sure the ribbon comes off the top of the supply spindle and feeds to the top of the take-up spindle.

'CLICK'

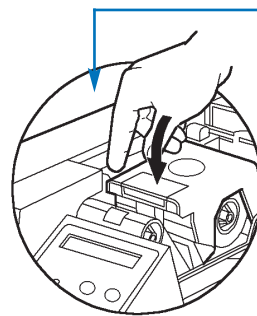

4. Push down on the print head lock lever until an audible 'click' signals the locked-down position. Please note that the ribbon automatically synchronises whenever the print head is locked down.

5. Close cover.



Please note that the ribbon automatically synchronises whenever the print head is locked down.

General information

Getting Started

Operation

Starting to Print Cards

Cleaning

Trouble Shooting

Technical Specifications

2.3 Loading Cards

To help you load, print, and collect cards, the J330 has the following item:

A - CARD CARTRIDGE

This item is used for loading cards.

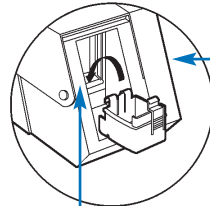

1. Install card cartridge by hooking onto printer as shown and clicking down.

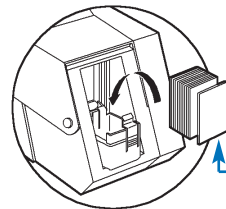

2. Install cards into card cartridge* as shown.

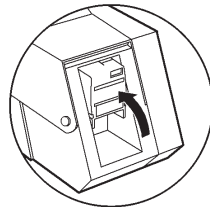

3. Close card cartridge.

General information

Getting Started

Operation

Starting to Print Cards

Cleaning

Trouble Shooting

Technical Specifications



DO NOT bend cards or touch print surfaces as this can reduce print quality. The surface of the cards must remain clean and dust free. Always store cards in an enclosed container. Ideally, use cards as soon as possible. If cards stick together, carefully shuffle them.

* See Chapter 6, Technical Specifications, for card requirements and capacities.

General information

Getting Started

Operation

Starting to Print Cards

Cleaning

Trouble Shooting

Technical Specifications

B - INSTALL CARD CLEANING CARTRIDGE

This item is used to clean the cards entering the printer and must be fitted before using the printer.

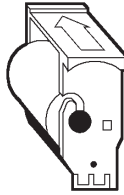

1. Remove card cleaning cartridge from packaging.

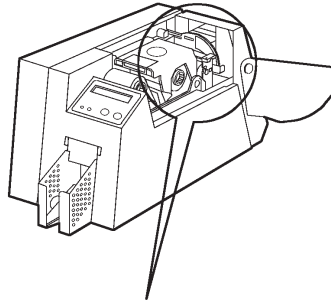

2. Open printer cover and remove the yellow reminder tape from the location for the cleaning cartridge.

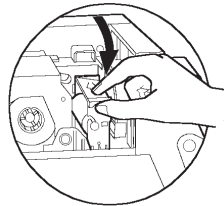

3. Make sure the arrow on top of the assembly is facing toward the rear of the printer. Hook assembly into slot on printer and rotate down. Ensure the assembly locks in place.

General information

Getting Started

Operation

Starting to Print Cards

Cleaning

Trouble Shooting

Technical Specifications

C - CARD THICKNESS CONTROL LEVER

This item is operated by the user to prevent more than one card feeding into the printer at the same time and causing a jam.

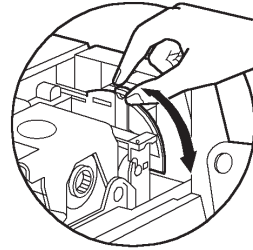

Open cover, and adjust lever to the correct position for the card thickness you are using. Repeat for different card thickness. (Factory setting is for 30mil (0.762 mm) card thickness). See diagram below :

Card thickness:

A - 60mil (1.524mm) to 50mil (1.27mm)

B - 40mil (1.016mm)

C - 30mil (0.762mm) - DEFAULT

D - 20mil (0.508mm)

E* - Less than 20mil (0.508mm)

* Start at lowest position and move lever up to match card thickness.

For other card thickness, start lever at lowest position and move up until cards feed.

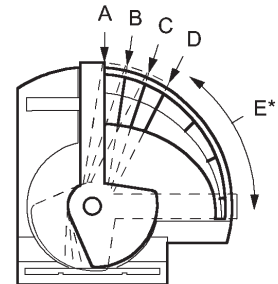

D - CARD OUTPUT HOPPER

This item is used for collecting printed cards.

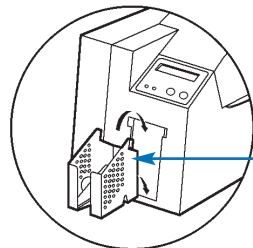

Install card output hopper to printer by hooking over bottom edge of card exit aperture.

General information

Getting Started

Operation

Starting to Print Cards

Cleaning

Trouble Shooting

Technical Specifications

2.5 Feeding one card at a time

A manual feed slot is available on the rear of the card cartridge cover for feeding single cards. Cleaning cards are fed manually through this slot.

The card cartridge must be empty for manual card feeding to work properly.

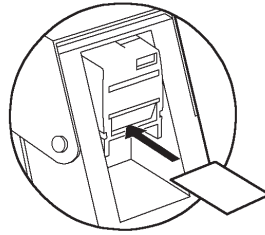

For one-at-a-time printing, feed cards through slot on rear of card cartridge.

Do not feed more than one card at a time.

General information

Getting Started

Operation

Starting to Print Cards

Cleaning

Trouble Shooting

Technical Specifications

2.6 Printing a Test Card

With ribbon and cards loaded, your J330 printer is ready to print. To check the operation of the printer you should print a test card.

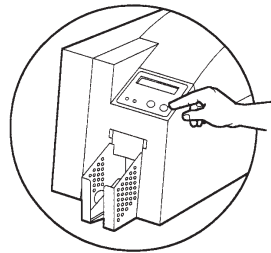

1. Press the menu button until the LCD screen shows "SELF TEST"
2. Then press the select button once.
3. Press select again to print a "Test Pattern".

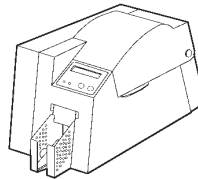

3. A test card will print after a few seconds. LCD display will show printing status. Test card is printed on both sides of the card.



This is an example of the test card.

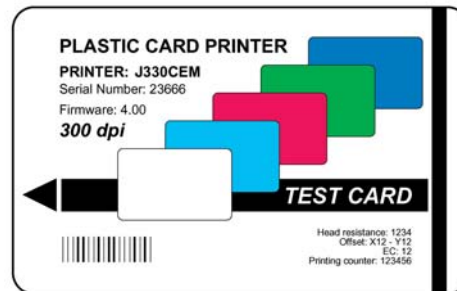

General information

Getting Started

Operation

Starting to Print Cards

Cleaning

Trouble Shooting

Technical Specifications

2.7 Printer Menu Information

The printer is equipped with a LCD Display and two key buttons which gives access to printer menus.

Select the menu button to enter the menu mode.

Menu Button [NEXT] →   ← **Clear Button** [SELECT]

The top line display shows menu information. The second line of display clarifies the function of the two [NEXT] and [SELECT] key buttons relative to the current menu item.

The printer will return to READY mode if either of the two key buttons is not pressed within ten seconds of entering menu mode.

J330 LCD MENU TREE

See next page:

General information

Getting Started

Operation

Starting to Print Cards

Cleaning

Trouble Shooting

Technical Specifications

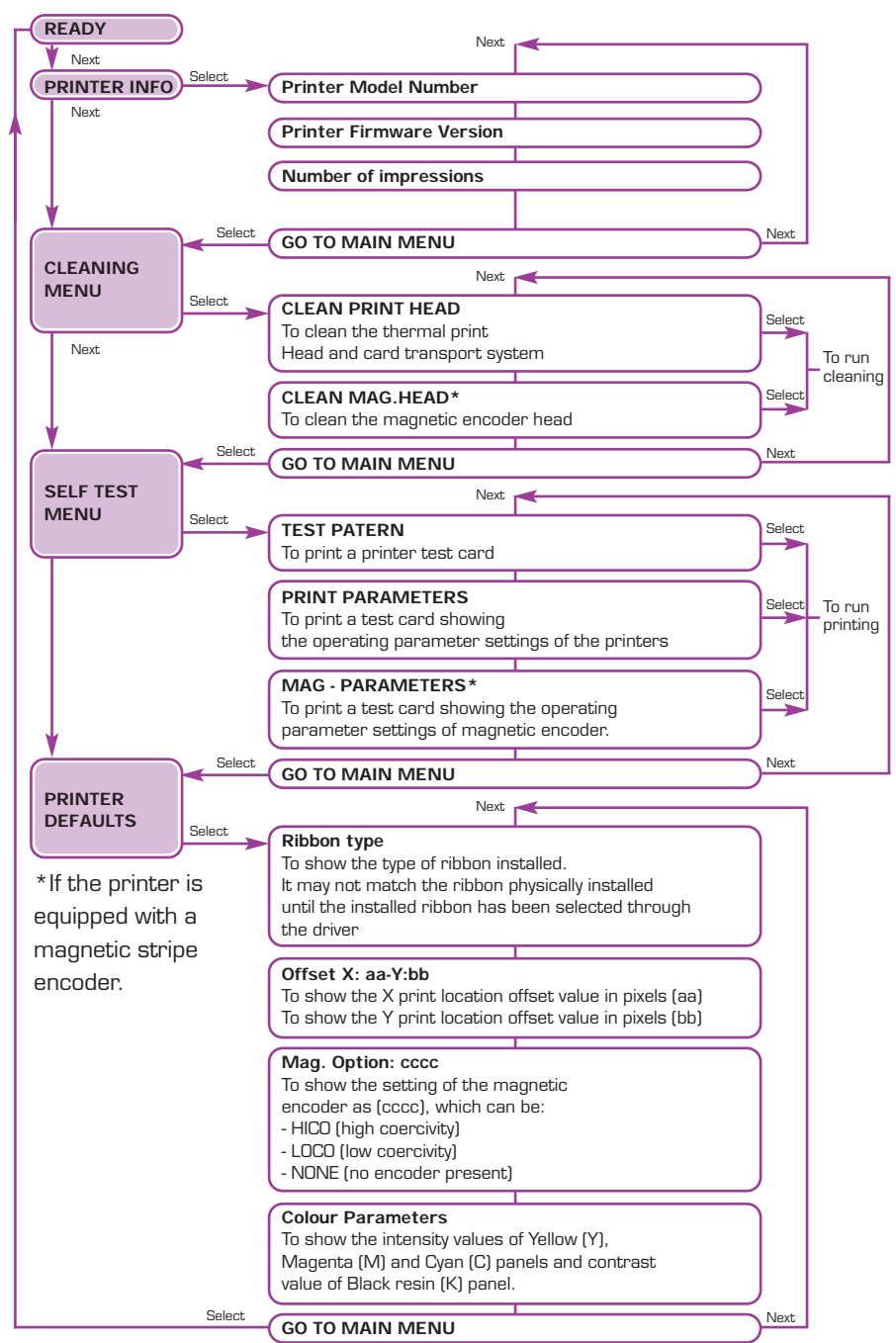

*If the printer is equipped with a magnetic stripe encoder.



J A V E L I N

3 Starting to print cards

Printing with the J330 printer requires the Windows Printer Driver, your card design/issuing software or printer command level programming through the printer interface.

The J330 card printer can be used with any Windows 95/98, ME, 2000 or NT 4.0 operating system, using the drivers provided with the printer. Updated drivers can be downloaded from the engenyus website www.engenyus.com

This section contains information on the printing of a single sided card in colour (using the 5-Panel colour ribbon YMCKO) and the Windows Printer Driver.

General information

Getting Started

Operation

Starting to Print Cards

Cleaning

Trouble Shooting

Technical Specifications

General
information

Getting
Started

Operation

Starting to
Print Cards

Cleaning

Trouble
Shooting

Technical
Specifications

A - TO INSTALL THE J330 PRINTER DRIVER IN
WINDOWS 95/98, USE THE FOLLOWING STEPS:

IMPORTANT NOTE - ENSURE THAT YOUR PC PRINTER PORT IS SET TO
STANDARD MODE AND ALSO ENSURE THAT YOU HAVE DELETED ANY
PREVIOUS VERSIONS OF THIS PRINTER DRIVER. IF YOU HAVE ANY DOUBTS
PLEASE CONTACT YOUR IT DEPARTMENT.

This installation uses CD drive 'D' as the installation drive with the printer used
as stand alone.

- Start your computer and then Windows.
- Insert your 'engenyus Printer Driver Software' CD into the drive 'D'.
- Under Windows click the **Start** button, select **Settings**, then **Printers**.
- Double click on the **Add Printer icon** and also Next.
- Ensure **Local Printer** is selected and click on Next.
- Click on **Have Disk** and then type in '**D:\win95-98**' and click OK.
- J330 CARD PRINTER should be displayed after which click on Next.
- Choose **LPT1 : Standard (or ECP) Printer Port**, click on Next, select **Yes**
to set as **Default Printer** and click on **Finish** to install.

The Printer Wizard will copy the necessary files to the PC for you
and the J330 printer driver installation will be completed.

General information

Getting Started

Operation

Starting to Print Cards

Cleaning

Trouble Shooting

Technical Specifications

B. TO INSTALL THE J330 PRINTER DRIVER IN WINDOWS NT4.0:

ENSURE THAT YOU HAVE ADMINISTRATIVE PRIVILEGES TO PERFORM THIS INSTALLATION OR CONTACT YOUR IT DEPARTMENT

Set printer as **Not Shared** for stand alone use.

Use the steps provided for Windows 95/98 installation with the exception of **step 6**. where you must type in '**D:\nt40**' instead and click OK.

Once the printer driver has been successfully installed, you will need to configure it for your printer. This driver provides control of several printer features when printing from Windows applications.

C. SET PRINTER DRIVER OPTIONS. WINDOWS NT

The printer settings can be accessed by selecting the **J330 Plastic Card Printer** driver from within **Printers**. Under Windows NT the printer properties are separated into two distinct pages, Document Defaults and Printer Properties. Highlight the printer icon and right click to open the following options.

Document Defaults

The page set-up window allows the number of copies to be set and the option of portrait or landscape.

The advanced settings are:

- Card: colour conversion, and image rotation.
- Ribbon: type of ribbon and use of the black panel.
- Printer: printer colour settings.

Properties

Within the device setting's window are the machine options such as:

- Print full size cards, smart download.
- Magnetic encoder settings
- Toolbox, from the toolbox, self-test printing station can be chosen to produce a test card.

General information

Getting Started

Operation

Starting to Print Cards

Cleaning

Trouble Shooting

Technical Specifications

D. SET PRINTER DRIVER OPTIONS . WINDOWS 95/98

The printer settings can be accessed by selecting the **J330 plastic card printer** driver from within printers. Highlight the printer icon and right click to open the following options:

- Card: Portrait/Landscape printing, image rotation and number of copies
- Colour: printing and screen colour settings
- General
- Sharing
- Colour management
- Details

E. SET PRINTER DRIVER OPTIONS AND PRINTING A TEST CARD.

The J330 Printer screen appears. Change the options as follows:

1. On the **PRINTER** tab configure the magnetic encoder feature. If your printer is equipped with a magnetic encoder option, select **WITH MAGNETIC ENCODER** option.
2. On the **CARD** tab select card orientation: landscape or portrait - select '**LANDSCAPE**'.
3. On the **RIBBON** tab, select the ribbon type. Select YMCKO for the standard 5-panel ribbon.
4. In the same tab, go to **BLACK PANEL** area and select **TEXT ONLY**. This option allows black text, bar codes or logos to be printed using the black resin panel from the colour ribbon.
5. Finally, go back to the **PRINTERS TAB** and click on **TOOLS** and then **SELF TEST PRINTING STATION**. The J330 will print a self test card which should be kept for reference in a safe place in case of any query

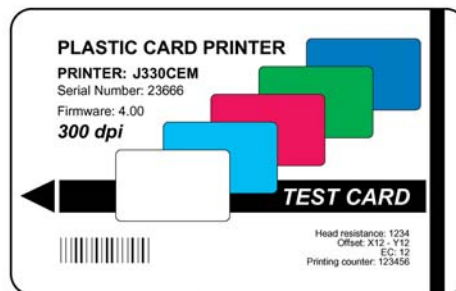

6. Close the engenyus J330 **PRINTER PROPERTIES** screen.

Now that you have loaded media and set up the printer driver, the J330 printer is ready to print.

4 Cleaning



PROTECT YOUR FACTORY WARRANTY !

The recommended maintenance procedures must be performed to maintain your factory warranty.

Other than the recommended cleaning procedures described in this manual, allow only engenyus authorised technicians to service the J330 printer.

NEVER loosen, tighten, adjust, or bend, etc. a part or cable inside the printer.

NEVER use a high pressure air compressor to remove particles in the printer.

General information

Getting Started

Operation

Starting to Print Cards

Cleaning

Trouble Shooting

Technical Specifications

General information

Getting Started

Operation

Starting to Print Cards

Cleaning

Trouble Shooting

Technical Specifications

4.1 Cleaning System

Your J330 printer includes a simple cleaning system using the pre-saturated cleaning cards provided. The regular use of these cards will clean and maintain important parts of your printer: including the print head, and transport rollers.

CLEAN PRINTER

WHEN TO CLEAN

When LCD screen reports message.

HOW TO CLEAN

1. Leave power on.

Open cover and release print head bracket to remove ribbon

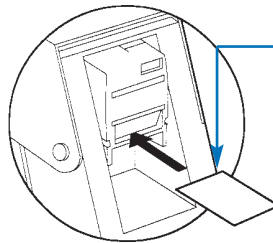

2. Remove any normal cards from the card cartridge.

Insert one pre-saturated cleaning card (provided) through slot on the rear of the card cartridge. Close the print head bracket. Close the cover.

3. Press the right panel button for a few seconds.

The card will feed into printer and carry out the cleaning process. Repeat the process with a new cleaning card if necessary.

Note: For a printer cleaning prior to the WHEN TO CLEAN signal, press the left panel button until the LCD screen shows "CLEANING MENU". Press the right panel button to select and one more time again to run the cleaning process (Repeat first steps 1 & 2 above).



Although the CLEAN PRINTER message is displayed until the cleaning process has been performed, the printer will continue to operate.

General information

Getting Started

Operation

Starting to Print Cards

Cleaning

Trouble Shooting

Technical Specifications

4.2 Cleaning the Print Head

Cleaning the printer using the cleaning system with cards usually suffices. However, cleaning the print heads using swabs can remove more stubborn deposits when print anomalies persist. To avoid deposits, only use foam-tipped swabs.

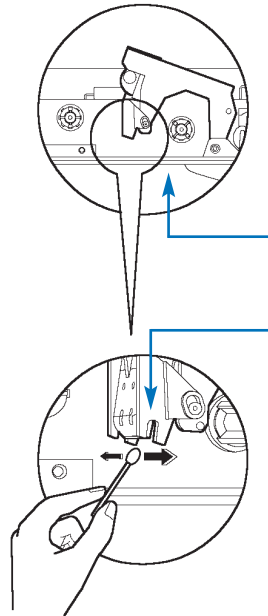

1. Raise print head and remove the ribbon.

2. Clean print head by moving the alcohol moistened swab tip side-to-side across print head elements. Only use moderate force. (To re-order swabs see Appendix C).



Never use a sharp object to scrape deposits from the print head. Permanent damage will result.

General information

Getting Started

Operation

Starting to Print Cards

Cleaning

Trouble Shooting

Technical Specifications

4.3 Card Cleaning Cartridge

Your J330 printer also has a card cleaning cartridge. This item cleans the cards entering the printer. To ensure print quality, the adhesive cleaning roller requires periodic replacements.

CLEAN PRINTER

WHEN TO MAINTAIN

When LCD screen reports message.

Run a printer cleaning first .

(see 4.1 Cleaning System for more instructions.)

HOW TO MAINTAIN

1. Open cover and locate cleaning cartridge.

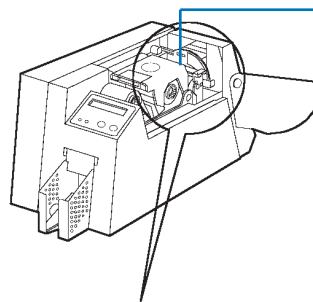

2. Gently remove cleaning cartridge by rotating up and away from printer.

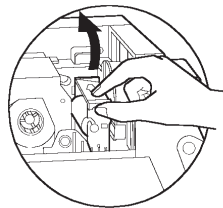

Continued on next page...

General information

Getting Started

Operation

Starting to Print Cards

Cleaning

Trouble Shooting

Technical Specifications

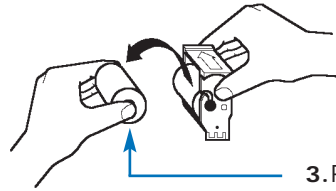

3. Remove the adhesive cleaning roller from cartridge and discard.

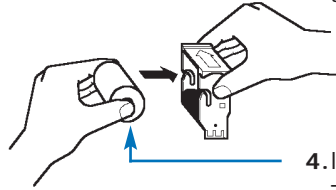

4. Install new cleaning roller into cartridge*. To avoid contamination, always hold the cleaning roller assembly by the ends.

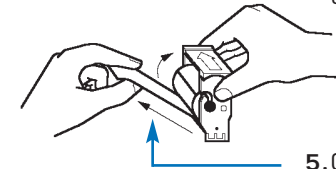

5. Carefully peel off wrapper from new cleaning roller while in cartridge.

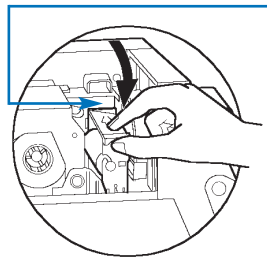

6. Replace cartridge into printer. Make sure the arrow on top of the assembly is facing toward the rear of the printer. Hook assembly into slot on printer and rotate down. Ensure the assembly locks in place.

DO NOT touch the roller surface that contacts the cards.

7. Close cover

* See Appendix C for replacement cleaning rollers.



Although the CLEAN PRINTER message is displayed until maintenance has been performed, the printer will continue to operate.

5 Troubleshooting

This section offers solutions to potential problems you may experience with your J330 printer. The table below lists the screen messages that will be displayed on the printer's LCD, both during normal operation and to alert operator of any error conditions. There is also some additional information dealing with quality issues concerning printing onto cards.

5.1 Interpreting LCD Display messages

SCREEN MESSAGE	MEANING	ACTION
INITIALISING	The printer is performing an internal test before use	Wait for READY message
READY	Ready for use	
WAIT TEMPERATURE	Print head cool down mode	Wait for READY message
SELF TEST	Self test card printing	Wait for test card
DOWNLOADING DATA	The card data is being transmitted	Wait for card printing to start
PRINTING YELLOW	The yellow panel is being printed	
PRINTING MAGENTA	The magenta panel is printing	
PRINTING CYAN	The cyan panel is printing	

General information

Getting Started

Operation

Starting to Print Cards

Cleaning

Trouble Shooting

Technical Specifications

General information

Getting Started

Operation

Starting to Print Cards

Cleaning

Trouble Shooting

Technical Specifications

SCREEN MESSAGE	MEANING	ACTION
PRINTING BLACK	A monochrome panel is being printed	
PRINTING VARNISH	The overlay is printing	
PRINT HOLOGRAM	A hologram overlay is printing	
CLEAN PRINTER	The printer is prompting the operator maintenance	Carry out the cleaning procedure as detailed in section 4 of this manual
CLEAN MAG HEAD	The printer is prompting the operator	Carry out the cleaning procedure as detailed in Appendix A of this manual
CLEANING	The printer is performing an internal cleaning routine	
REMOVE RIBBON	The ribbon has not been removed while the cleaning operation is in progress	Remove ribbon
OUT OF RIBBON	The printer ribbon has run out	Replace printer ribbon
MECHANICAL ERROR	The printer has an error moving the card internally	Remove the jammed card. Ensure that the card is not out of specification, ensure the cleaning cartridge is correctly fitted!
OUT OF CARD	The card cartridge is empty, or the card has mis-fed	Add more cards or adjust the card feeder to accept the cards
COVER OPEN	The cover is open	Close the cover
HEAD OPEN	The print head is not locked into position	Lock the print head in its lower position
COMMAND ERROR	The data being sent from the host is not recognised	Check that the data is suitable for printing. Try reprinting a card from known 'good' data
PARAMETERS ERROR	The features of the card are not recognised	Check the Windows driver options, magnetic data and printer type

General information

Getting Started

Operation

Starting to Print Cards

Cleaning

Trouble Shooting

Technical Specifications

SCREEN MESSAGE	MEANING	ACTION
ENCODING ERROR	Data cannot be written or read from the card's magnetic stripe	Check that the cards are loaded with the magnetic stripe in the correct orientation. Check whether high or low coercivity cards have been specified. Check that the data conforms to ISO specifications. See Appendix A of this manual for further information.
READING ERROR	Data cannot be read from the card's magnetic stripe	Check that the cards are loaded with the magnetic stripe in the correct orientation. Check whether high or low coercivity cards have been specified. Check that the data conforms to ISO specifications. See Appendix A of this manual for further information.
MAGNETIC ERROR	The printer cannot detect a magnetic stripe on the card.	Check the card orientation
FLASH ERROR		Contact your dealer for technical support.
NO ACCESS		

Ribbon Errors: Check that the print ribbon has not 'run out'. Lock and then unlock the print head assembly; this resynchronises the ribbon automatically. When using a colour ribbon, it should advance automatically so that the leading edge of the yellow panel is beneath the print head. Ensure that the correct ribbon type has been specified in the Windows driver.

Card Feed & Mechanical Errors: Ensure that the card thickness adjustment has been set-up correctly to allow one card to feed.

Continued on next page...



General information

Getting Started

Operation

Starting to Print Cards

Cleaning

Trouble Shooting

Technical Specifications

Magnetic Encoding Errors: Check that the cards are inserted correctly in the printer. Ensure that the cards are low or high coercivity as required, and are set-up correctly in the printer driver.

Cleaning Alert: The printer has counted the number of cards printed and has automatically flagged that a cleaning routine needs to be carried out. (See Chapter 4).

5.2 Print Quality Issues

This section will help you resolve print quality problems. The print quality is dependent on several factors. The two most important factors that will increase your print quality are cleanliness and card stock. To diagnose and fix print quality problems, follow the troubleshooting procedure below:

- **Small spots appear on the printed card with a non-printed area or a different color.**

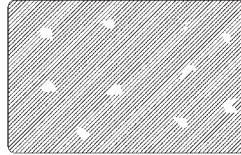

Possible Cause

- A. Contamination on the card surface.
- B. Dust inside the printer and/or dirty cleaning roller.

→ Solution

- A1. Check that cards are stored in a dust free environment
- A2. Use a different supply of cards.
- B1. Perform a cleaning of the printer (see cleaning section).
- B2. Replace cleaning roller (see cleaning section).

- **There are non-printing horizontal lines (white) on the card surfaces.**

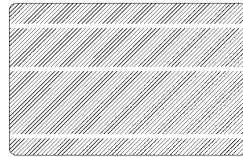

Possible Cause

- A. Ribbons is not correctly positioned.
- B. Print head may be dirty.
- C. Print head elements may have been damaged (e.g. scratched or burnt).

→ Solution

- A1. Open cover and press down the print head unlock lever to open the print head carriage. The print head will move up.
- A2. Check that the ribbon is properly rolled onto the ribbon cores and there are no wrinkles in the ribbon.
- A3. Push down on the print head lock lever until an audible “click” signals the locked-down position.
- A4. Ribbon will automatically synchronize.
- A5. Print again.
- B1. Perform a cleaning of the print head (see 4.2 Cleaning the print head.)
- C1. Call service for print head replacement information.

General information

Getting Started

Operation

Starting to Print Cards

Cleaning

Trouble Shooting

Technical Specifications

• **Printing shows very pale or inconsistent results.**

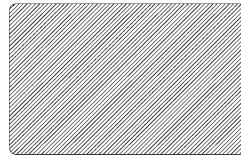

Possible Cause

- A. Ribbon may have been stored improperly or is damaged.
- B. Cards may not meet specifications.
- C. Contrast and/or Intensity may be set to values which are too high.
- D. Dust or embedded contamination on elements of the Print head.

→ **Solution**

- A1. Change ribbon and print again.
- B1. Use a different supply of cards.
- C1. Adjust contrast and/or Intensity values in software
- D1. Perform a cleaning of the Print head (see 4.2 Cleaning the print head.)

• **Printing shows blurry printed image.**



Possible Cause

- A. Ribbon may not be correctly positioned
- B. Ribbon may not be synchronized on the correct color panel position.
- C. Cards may not meet specifications.
- D. Dust inside the printer and/or dirty cleaning roller.

→ **Solution**

- A1. Open cover and press down the print head unlock lever to open the print head carriage. The print head will move up.
- A2. Check ribbon is properly rolled on ribbon cores.
- A3. Push down on the print head lock lever until an audible "click" signals the locked-down position.
- A4. Ribbon will automatically synchronize.
- A5. Print again.

Continued on next page...

General information

Getting Started

Operation

Starting to Print Cards

Cleaning

Trouble Shooting

Technical Specifications

- B1. Open cover and press down the print head unlock lever to open the print head carriage. The print head will move up.
- B2. Push down on the Print Head Lock Lever until an audible «click» signals the locked-down position.
- B3. Ribbon will automatically synchronize.
- B4. Print again.
- C1. Use a different supply of cards.
- D1. Perform a cleaning of the print head (see 4.2 Cleaning the print head.)
- D2. Replace cleaning roller (see 4.3 Cleaning cartridge.)
Printing shows blurry printed image.

• **No printing on the card.**



Possible Cause

- A. Ribbon may not be installed in the printer
- B. Cards may not meet specifications.
- C. Cable on print head may be disconnected.
- D. Print head elements may be scratched or burnt.

→ **Solution**

- A1. Check for ribbon in the printer.
- B1. Use a different supply of cards.
- C1. Power off the printer and check the print head cable connections.
- D1. Call service for print head replacement information.



For optimum print quality, always keep cover of the printer closed except during ribbon loading and card thickness control procedures.

The card flipper will not operate and an error will be indicated if you try to flip a card with the cover open.



J A V E L I N

6 Technical Specifications

General

- High speed printing, over 144 cards/hour edge to edge in full colour (YMCKO) throughput
- Small footprint
- Windows Drivers for 95/98, NT 4.0, ME, 2000.
- One year printer warranty
- One year print head warranty

Colour Printing

- Colour dye sublimation or monochrome thermal transfer printing
- 25 seconds per card (YMCKO) throughput
- 300 dpi (11.8 dots/mm) print resolution
- Edge to edge printing standard

Fonts

- Resident: Arial Normal 100, Arial Bold 100
- True Type fonts available via Windows Driver

Cards

- Types PVC, Composite
- Card width/length: ISO CR-80 - ISO 7810, 2.125" (54mm) by 3.375" (86mm)
- Option: Magnetic Stripe - ISO 7811
- Option: Smart Card - ISO 7816-2
- Card thickness: 0.25mm to 1.524mm
- Card feeder capacity: up to 240 cards (10mil), up to 80 cards (30 mil)
- Card output hopper capacity: 300 cards (10mil), up to 100 cards (30 mil)

General information

Getting Started

Operation

Starting to Print Cards

Cleaning

Trouble Shooting

Technical Specifications

General information

Getting Started

Operation

Starting to Print Cards

Cleaning

Trouble Shooting

Technical Specifications

CARD DIMENSIONS

ISO STANDARD DIMENSIONS FOR PLAIN CARD

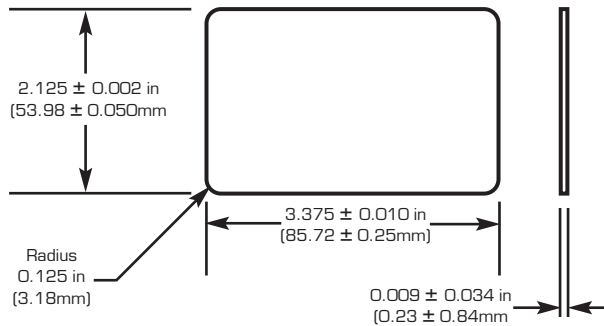

ISO STANDARD DIMENSIONS FOR MAGNETIC STRIPE CARD

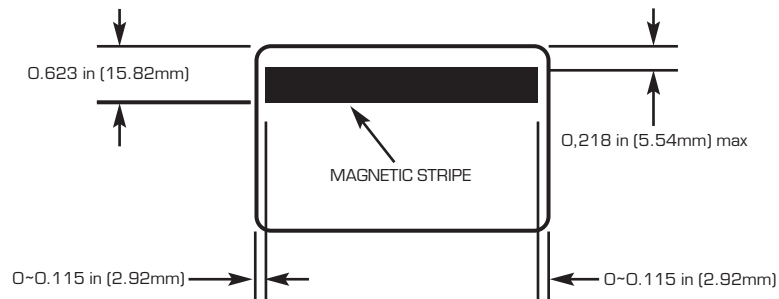

CHIP POSITION FOR SMART CARD

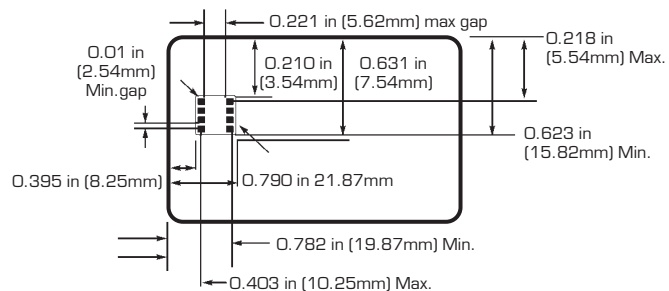

General information

Getting Started

Operation

Starting to Print Cards

Cleaning

Trouble Shooting

Technical Specifications

Ribbons*

- Monochrome: 1000 cards/roll
- Monochrome colours: black, red, blue, green, silver, gold, white, scratch-off.
- Monochrome: 1500 cards/roll (black only)
- K-resin + O: 500 cards/roll
- K-dye + O: 500 cards/roll
- YMCKO: 200 or 350 cards/roll

Thermal transfer (Resin) ribbons offer more durability than dye sublimation, with greater resistance to scratches and UV-induced fading.

Dye Sublimation printing requires dye sublimation ribbons, with either black or cyan, magenta, and yellow (plus black resin) panels.

Overlay Varnish

- Thermal transfer
- 4 microns thick
- Clear and holographic options:
 - Clear
 - Genuine/Secure Hologram
 - Custom Hologram

Interfaces

- Centronics Parallel Standard
- RS-232C Serial (Optional)
- USB port (Optional)

Mechanical

- Width: 17.25" (438 mm[†])
- Depth: 7.5" (191 mm)
- Height: 9" (229 mm)
- Weight: 21lbs (9.5 kg)

[†] Measured without card output hopper.

Electrical

- 110 ~ 230 Volts AC, 60 ~ 50 Hz
- FCC Class A, CE, UL, and CUL approved

General information

Getting Started

Operation

Starting to Print Cards

Cleaning

Trouble Shooting

Technical Specifications

Environmental

- Operating Temperature: 60 to 86°F (15 to 30°C)
- Operating Humidity: 20 to 65% non condensing
- Storage Temperature: -23 to 158°F (-5 to 70°C)
- Storage Humidity: 20 to 70% non condensing
- Ventilation: Free air

Options & Accessories

- Centronics Cable (1.8 or 3.0 metres)
- RS-232C serial port
- USB port
- Smart Card Contact Station (0.76mm cards only)
- Magnetic Encoder (0.76mm cards only)
- Cleaning supplies
- Service Manual



For best results use engenyus-approved cards and TrueColours™ ribbon media. Using non-approved cards or ribbon media can void your warranty.

Refer to the Accessories section for more information about cards and ribbon media available from engenyus.



J A V E L I N

Appendix A

Magnetic Card Stripe Encoder

This section contains information on the additional operations of the J330 printers with magnetic card stripe encoder. (See Chapter 2 for location.)

INTRODUCTION

Operation and maintenance requirements for the J330 printer with the optional magnetic card stripe encoder. (See Chapter 2 for location). The magnetic encoder can be set for either high or low coercivity.

General information

Getting Started

Operation

Starting to Print Cards

Cleaning

Trouble Shooting

Technical Specifications

General
information

Getting
Started

Operation

Starting to
Print Cards

Cleaning

Trouble
Shooting

Technical
Specifications

A. MEDIA LOADING ORIENTATION

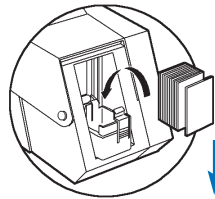

The magnetic encoder is a factory installed item with the read/write head positioned below the card path, available with HICO encoding or LOCO encoding .

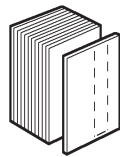

STRIPE
DOWN

When loading cards into the card cartridge, please ensure that the magnetic stripe is facing down and closest to the rear.

Also available are printer models with the magnetic read/write head positioned above the card path, with HICO encoding or LOCO encoding .



STRIPE
UP

When loading cards, please ensure that the magnetic stripe is facing up and closest to the rear.

Approved HICO & LOCO PVC cards are available. (See Appendix C).



ONLY USE cards that comply with ISO 7810 & 7811 standards for magnetic stripe cards. The magnetic stripe must be flush to the surface of the card to work properly. Never use taped-on magnetic stripes.

General information

Getting Started

Operation

Starting to Print Cards

Cleaning

Trouble Shooting

Technical Specifications

B. MAGNETIC ENCODER CLEANING

There exists two different processes to clean the magnetic stripe encoder. The first process consists of a standard cleaning of the printer. This cleans the most important parts of the printer; including the print head, transport roller and magnetic stripe encoder (refer to chapter 4 Cleaning for more instructions).

The second process consists of a cleaning of the magnetic encoder using the menu button from the LCD Display.

To access the magnetic encoder cleaning menu proceed as below:

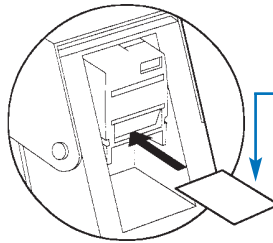

1. Leave power on.
2. Remove cards from the card cartridge
3. Insert one pre-saturated cleaning card (provided) through slot on the side of the card cartridge.
4. Press the menu button until the LCD screen shows CLEANING MENU.
5. Press the select button to select.
6. Press the menu button again until the LCD screen shows CLEAN MAG HEAD.
7. Run this operation by pressing the select button.

ISO STANDARD ENCODING

Track #	Field Separato	Track density	Valid Characters	# of characters
1	^	210BPI*	Alphanumeric (ASCII 20~95†)	79‡
2	=	75BPI*	Numeric (ASCII 48~62)	40‡
3	=	210BPI*	Numeric (ASCII 48~62)	107‡

* Bit per inch

† Except the '?' character

‡ Including Start, Stop and LRC characters. Also note that these 3 characters are automatically managed by the magnetic encoder according to the ISO Standard Norms.

NOTE: Refer to the card printer programmer's manual for complete programming information.



J A V E L I N

Appendix B

Smart Card Contact Station

This section contains information on the additional operations of the J330 printers with smart card contact stations. (See Chapter 2 for location.)

INTRODUCTION

Smart cards can be either 'memory' cards or contain memory and a microprocessor. Data can be stored such as the holder's personal details together with advanced features such as security algorithms and biometric data such as fingerprint patterns.

The Javelin J330 CE and J330 CEM printers have a contact station to connect a serial interface to the smart card contacts. A suitable smart card coupler and associated software would be required external to the printer to communicate with the smart card. engenyus offers a range of integrated couplers (as detailed on page 43) for both contact, contactless (mifare) and 'combi' cards.

The J330 may be equipped with an optional contact station for programming smart cards (ISO 7816). This printer model responds to commands that position the cards at the contact station, where the printer connects to the contacts on the smart cards. All other printer operations remain the same as the standard J330 model.

General
information

Getting
Started

Operation

Starting to
Print Cards

Cleaning

Trouble
Shooting

Technical
Specifications

General
information

Getting
Started

Operation

Starting to
Print Cards

Cleaning

Trouble
Shooting

Technical
Specifications

A. MEDIA LOADING ORIENTATION

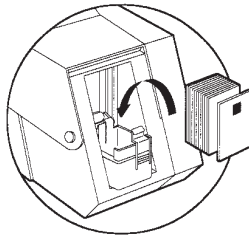

Position the cards with the smart card chip at the top of the card and towards the printer.

B. SMART CARD CONTACT STATION INTERFACE

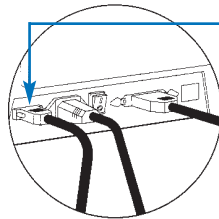

When a command to the parallel printer interface sends a card to the smart card contact station, the printer connects the smart card contact station to the female DB-9 connector on the rear of the printer.

An attached external smart card programmer can be used to program smart card chips.

DB - 9 PINS	SMART CARD CONTACT POINTS	DB - 9 PINS	SMART CARD CONTACT POINTS
1	C1 (Vcc)	6	C6 (Vpp)
2	C2 (Reset)	7	C7 (I/O)9
3	C3 (Clock)	8	C8 (RFU)
4	C4 (RFU)	9	(GND when chip is at station)
5	C5 (GND)		

Refer to the card printer programmer's manual for complete programming information.



DO NOT position printing over the smart card chip.

Appendix C

Accessories & supplies

Please contact your engenyus dealer to place an order for accessories and supplies.

RIBBONS

The J330 prinjet requires approved ribbons for optimum performance and print head life. The following ribbons may be used in the J330 printer:

Monochrome Resin Ribbons (sold by the roll)	
engenyus Part Number	Description
6 11 31 101	Black (1000 cards)
6 11 32 101	Black (1500 cards)
6 11 31 102	Red (1000 cards)
6 11 31 103	Green (1000 cards)
6 11 31 104	Blue (1000 cards)
6 11 31 106	White (1000 cards)
6 11 31 111	Gold (1000 cards)
6 11 31 112	Silver (1000 cards)
6 11 31 121	Scratch-off Grey (1000 cards)

Colour Ribbons (sold by the roll)	
engenyus Part Number	Description
6 11 31 501	5-panel (YMCKO) (200 cards)
6 11 32 501	5-panel (YMCKO) (350 cards)
6 11 31 201	2-panel (K dye + O) (500 cards)
6 11 31 202	2-panel (K resin + O) (500 cards)

Note :

Y = Yellow, M = Magenta, C = Cyan, B = Black , O = Overlay

Monochrome resin ribbons are suitable for printing text, graphics and bar codes, but not images.

K dye + O ribbons are recommended for printing monochrome images.

General
information

Getting
Started

Operation

Starting to
Print Cards

Cleaning

Trouble
Shooting

Technical
Specifications

**General
information**

**Getting
Started**

Operation

**Starting to
Print Cards**

Cleaning

**Trouble
Shooting**

**Technical
Specifications**

CARDS

The following plain white plastic cards are available for use in the J330 printers:

engenyus Part Number	Description
9 104 523 111	Cards with no magnetic stripe
9 104 523 112	Cards with low coercivity magnetic stripe
9 104 523 113	Cards with high coercivity magnetic stripe
9 104 523 110	Self-adhesive cards to fix onto proximity cards

Many other card types are also available; ask your dealer for more information.

**General
information**

**Getting
Started**

Operation

**Starting to
Print Cards**

Cleaning

**Trouble
Shooting**

**Technical
Specifications**

ACCESSORIES

Accessories available for J330 Printers are listed below:

engenyus Part Number	Description
2 33 11 000	engenyus Mifare (contactless) encoding kit to be fitted to J330C or J330CM printer. Includes integrated Mifare encoder software tools, RS232C interface and documentation
2 33 13 000	engenyus Smart Card (contact) encoding kit to be fitted to J330C or J330CEM printer. Includes integrated smart card coupler, software tools, RS232 interface and documentation
2 33 12 000	engenyus combined Smart Card (contact) & Mifare (contactless) card encoding kit to be fitted to J330CE or J330CEM printer. Includes integrated smart card coupler, software tools, RS232C interface and documentation
4 50 11 000	engenyus Software Developer's Kit (SDK). Includes smart card reader and training at engenyus.
6 11 00 915	Cleaning kit: cleaning cards (100) and swabs (25)
6 11 00 902	Replacement print head kit
6 11 00 912	Cleaning roller kit (5)
6 11 00 913	Card cleaning cartridge
2 40 10 000	USB connector and cable
2 42 62 330	1.8m Centronics Cable
2 42 62 421	3.0m Centronics Cable